

### FEATURES

- Power pack
- Metal silicon junction ,majority carrier conduction
- Guard ring for overvoltage protection
- Low power loss ,high efficiency
- High current capability ,low forward voltage drop
- High forward surge capability
- High frequency operation
- Per J-STD-020,LF MAX peak of 260°C (for TO-263 package)
- Solder bath temperature 275°C maximum,10s,per JESD22-B106 (for TO-220AB and ITO-220AB package)
- Component in accordance to RoHS 2015/863/EU

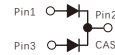

TO-220AB

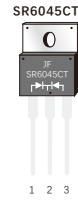

ITO-220AB

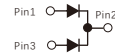
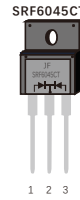

TO-263  
SR6045D1

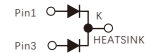

### MECHANICAL DATA

- Case: JEDEC TO-220AB、ITO-220AB、TO-263
- Molding compound meets UL94V-0 flammability rating
- Terminals: Lead solderable per J-STD-002 and JESD22-B102
- Polarity: As marked
- Mounting Torque: 10 in-lbs maximum

### TYPICAL APPLICATIONS

For use in low voltage ,high frequency inverters ,DC/DC converters,free wheeling ,and polarity protection applications

### MAXIMUM RATINGS

(Ratings at 25°C ambient temperature unless otherwise specified )

| Parameter  | Symbol                           | Value      | Unit |
|--|----------------------------------|------------|------|
| Maximum repetitive peak reverse voltage  | V <sub>RRM</sub>                 | 45         | V    |
| Maximum average forward rectified current,D=0.5, Square waveform,T <sub>c</sub> ≤110°C for TO-220AB and TO-263, T <sub>c</sub> ≤30°C for ITO-220AB (see Fig.1) | Per leg                          | 30.0       | A    |
|  | Total device                     | 60.0       |      |
| Peak forward surge current 8.3ms single half sine-wave superimposed on rated load (JEDEC method at rated TL, Per Leg)  | I <sub>FSM</sub>                 | 300        | A    |
| Operating junction and Storage temperature range   | T <sub>J</sub> ,T <sub>stg</sub> | -55 to+150 | °C   |

## ELECTRICAL CHARACTERISTICS (T<sub>A</sub>=25°C Unless otherwise noted)

| Parameter                     | Test Conditions                  |                       | Symbol                       | Typ  | Max  | Unit |
|-------------------------------|----------------------------------|-----------------------|------------------------------|------|------|------|
| Instantaneous forward voltage | Per leg<br>I <sub>F</sub> =30.0A | T <sub>J</sub> =25°C  | V <sub>F</sub> <sup>1)</sup> | 0.58 | 0.62 | V    |
|                               |                                  | T <sub>J</sub> =100°C |                              | 0.57 | -    |      |
|                               |                                  | T <sub>J</sub> =125°C |                              | 0.56 | -    |      |
|                               | Per leg<br>I <sub>F</sub> =10.0A | T <sub>J</sub> =25°C  |                              | 0.44 | -    |      |
|                               |                                  | T <sub>J</sub> =100°C |                              | 0.37 | -    |      |
|                               |                                  | T <sub>J</sub> =125°C |                              | 0.34 | -    |      |
| Reverse current               | V <sub>R</sub> =45V              | T <sub>J</sub> =25°C  | I <sub>R</sub> <sup>2)</sup> | -    | 150  | μA   |
|                               |                                  | T <sub>J</sub> =100°C |                              | -    | 20   | mA   |
|                               |                                  | T <sub>J</sub> =125°C |                              | -    | 75   |      |
| Typical junction capacitance  | 4V, 1MHz                         |                       | C <sub>J</sub>               | 930  |      | pF   |

Notes: 1.Pulse test: 300μs pulse width,1% duty cycle

2.Pulse test: pulse width ≤40ms

## THERMAL CHARACTERISTICS

| Parameter                                | Symbol           | SR6045CT | SRF6045CT | SR6045D1 | Unit |
|--|------------------|----------|-----------|----------|------|
| Typical thermal resistance <sup>3)</sup> | R <sub>θJC</sub> | 0.8      | 3.0       | 0.8      | °C/W |

3.Thermal resistance from junction to case

## AVAILABLE PACK INFORMATION

| Product code        | Pack | Carton Size<br>L×W×H(mm) | Inner Box Size<br>L×W×H(mm) | Tube Length<br>(mm)   | Inner Box<br>Number | Tube Number<br>Per A Inner Box | Part Number<br>Per A Tube | Quantity(carton)<br>(K) |
|---------------------|------|--------------------------|-----------------------------|-----------------------|---------------------|--------------------------------|---------------------------|-------------------------|
| SR6045CT-TO-220AB   | Tube | 565×225×170              | 548×151×37                  | 540                   | 5                   | 20                             | 50                        | 5                       |
| SRF6045CT-ITO-220AB | Tube | 565×225×170              | 548×151×37                  | 540                   | 5                   | 20                             | 50                        | 5                       |
| SR6045D1-TO-263     | Tube | 565×225×170              | 548×151×37                  | 538                   | 5                   | 20                             | 50                        | 5                       |
| Product code        | Pack | Carton Size<br>L×W×H(mm) | Inner Box Size<br>L×W×H(mm) | Reel Diameter<br>(mm) | Inner Box<br>Number | Reel Number<br>Per A Inner Box | Part Number<br>Per A Reel | Quantity(carton)<br>(K) |
| SR6045D1-TO-263     | Reel | 364×364×235              | 330×330×38                  | φ330                  | 5                   | 1                              | 800                       | 4                       |

FIG.1-FORWARD CURRENT DERATING CURVE

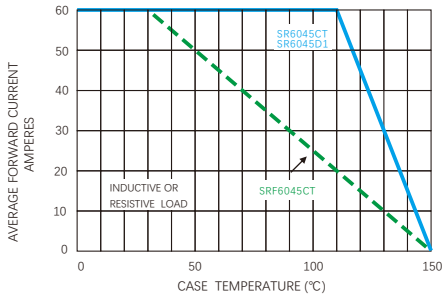

FIG.2-MAXIMUM NON-REPETITIVE PEAK FORWARD SURGE CURRENT

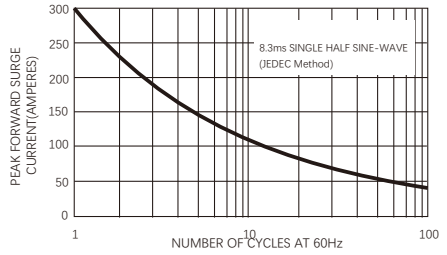

FIG.3-TYPICAL INSTANTANEOUS FORWARD CHARACTERISTICS

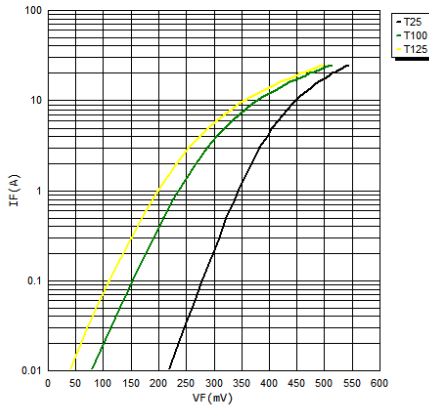

FIG.4-TYPICAL REVERSE CHARACTERISTICS

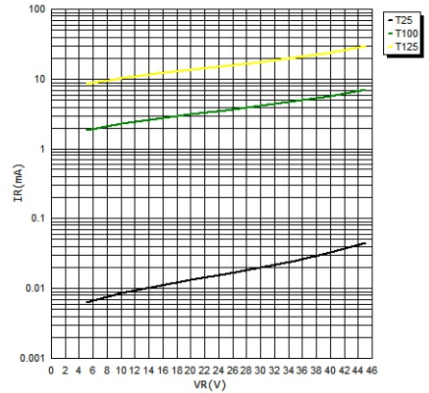
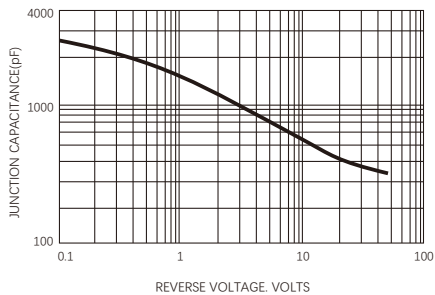
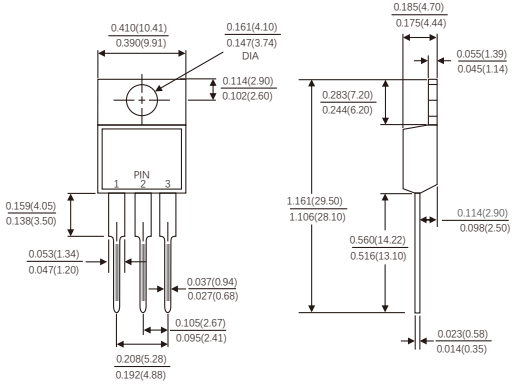

FIG.5-TYPICAL JUNCTION CAPACITANCE



Dimensions in inches and (millimeters)

## TO-220AB



## ITO-220AB

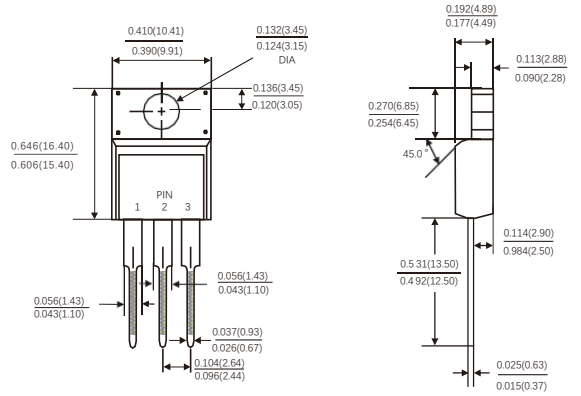

## TO-263

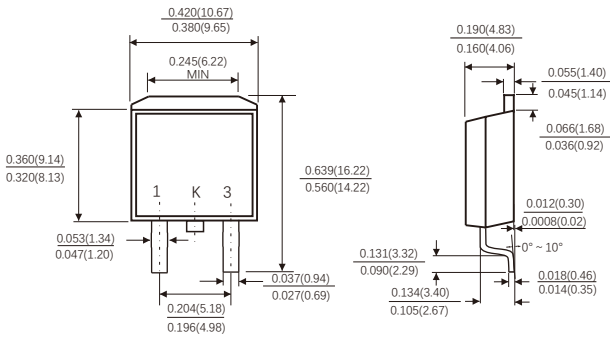

## Suggested Pad Layout

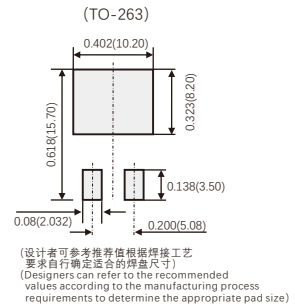

## Friendship Reminder

- JiNan JingHeng (hereinafter referred to as JH) reserves the right to make changes to this document and its products and specifications at anytime without notice.
- Customers should obtain and confirm the latest product information and specifications before final design, purchase or use.
- JH makes no warranty, representation or guarantee regarding the suitability of its products for any particular purpose, nor does JH assume any liability for application assistance or customer product design.
- JH does not warrant or accept any liability with products which are purchased or used for any unintended or unauthorized application.
- No license is granted by implication or otherwise under any intellectual property rights of JH.
- JH's products are not authorized for use as critical components in life support devices or systems without express written approval of JH.