

FEATURES

- Plastic package has Underwriters Laboratory Flammability Classification 94V-0
- Fast switching for high efficiency
- Low forward voltage drop
- Single rectifier construction
- High surge capability
- For use in low voltage ,high frequency inverters, free wheeling ,and polarity protection applications
- High temperature soldering guaranteed:260°C/10 seconds, 0.25"(6.35mm)from case
- Component in accordance to RoHS 2015/263/EU

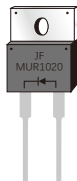

TO-220AC

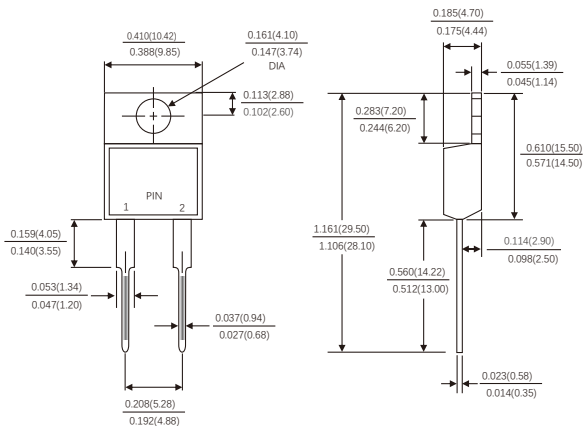

Dimensions in inches and (millimeters)

MECHANICAL DATA

- Case: JEDEC TO-220AC molded plastic body
- Terminals: Lead solderable per MIL-STD-750,method 2026
- Polarity: As marked
- Mounting Position: Any
- Weight: 0.08ounce, 2.24 gram

MAXIMUM RATINGS AND ELECTRICAL CHARACTERISTICS

(Ratings at 25°C ambient temperature unless otherwise specified ,Single phase ,half wave ,resistive or inductive load. For capacitive load,derate by 20%.)

Parameters	Symbols	MUR1020	MUR1040	MUR1060	Units
Maximum repetitive peak reverse voltage	V_{RRM}	200	400	600	Volts
Maximum RMS voltage	V_{RMS}	140	280	420	Volts
Maximum DC blocking voltage	V_{DC}	200	400	600	Volts
Maximum average forward rectified current(see Fig.1)	$I(AV)$	10.0			Amps
Peak forward surge current 8.3ms single half sine-wave superimposed on rated load (JEDEC method)	I_{FSM}	120			Amps
Maximum instantaneous forward voltage at 10.0 A(Note 1)	V_F	0.975	1.30	1.70	Volts
Maximum instantaneous reverse current at rated DC blocking voltage(Note 1)	$T_J=25^{\circ}C$	5.0			μA
	$T_J=125^{\circ}C$				
Maximum Reverse Recovery Time (Note 2)	T_{rr}	35			ns
Typical thermal resistance (Note 3)	$R_{\theta JC}$	2.5			$^{\circ}C/W$
Operating junction temperature range	T_J	-55 to+175			$^{\circ}C$
Storage temperature range	T_{STG}	-55 to+175			$^{\circ}C$

- Notes: 1. Pulse test: 300 μs pulse width,1% duty cycle
2. Reverse recovery test conditions $I_F=0.5A,I_R=1.0A,I_{rr}=0.25A$
3. Thermal resistance from junction to case

RATINGS AND CHARACTERISTIC CURVES MUR1020 THRU MUR1060

FIG.1-FORWARD CURRENT DERATING CURVE

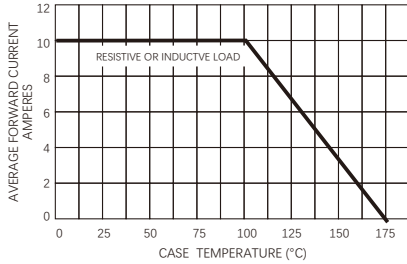

FIG.2-MAXIMUM NON-REPETITIVE PEAK FORWARD SURGE CURRENT

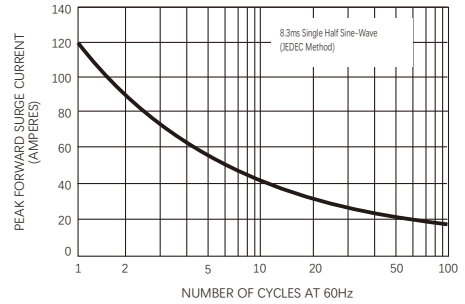

FIG.3-TYPICAL INSTANTANEOUS FORWARD CHARACTERISTICS

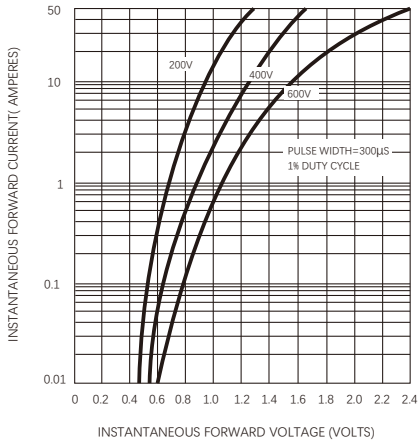

FIG.4-TYPICAL REVERSE CHARACTERISTICS

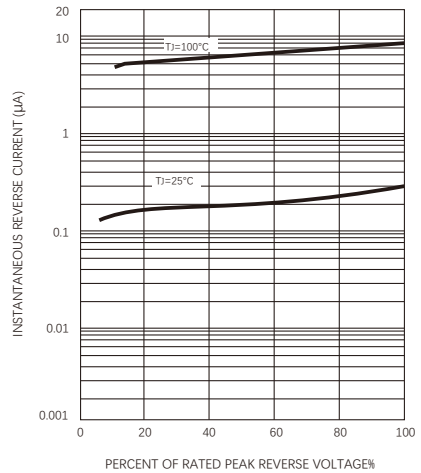

FIG.5-TYPICAL JUNCTION CAPACITANCE

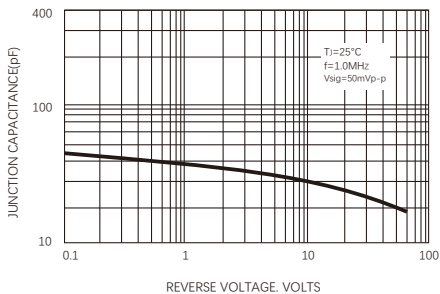
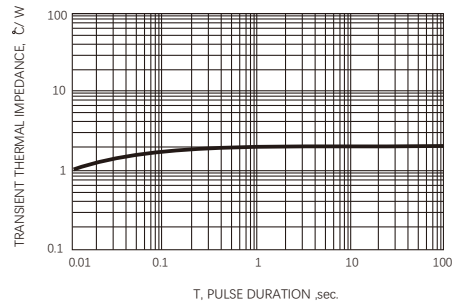

FIG.6-TYPICAL TRANSIENT THERMAL IMPEDANCE



Friendship Reminder

- JiNan JingHeng (hereinafter referred to as JH) reserves the right to make changes to this document and its products and specifications at anytime without notice.
- Customers should obtain and confirm the latest product information and specifications before final design, purchase or use.
- JH makes no warranty, representation or guarantee regarding the suitability of its products for any particular purpose, nor does JH assume any liability for application assistance or customer product design.
- JH does not warrant or accept any liability with products which are purchased or used for any unintended or unauthorized application.
- No license is granted by implication or otherwise under any intellectual property rights of JH.
- JH's products are not authorized for use as critical components in life support devices or systems without express written approval of JH.